

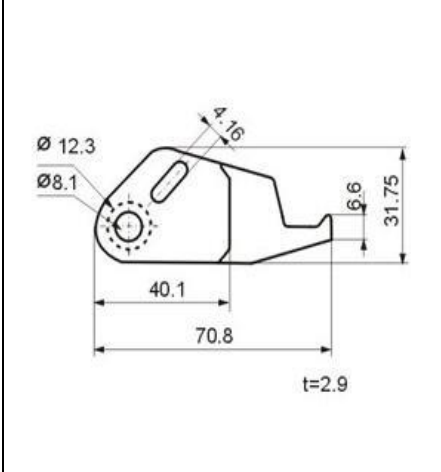









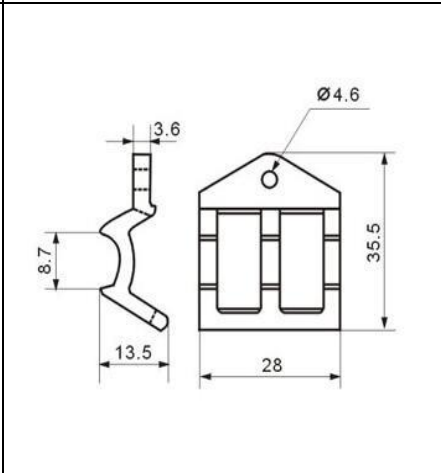

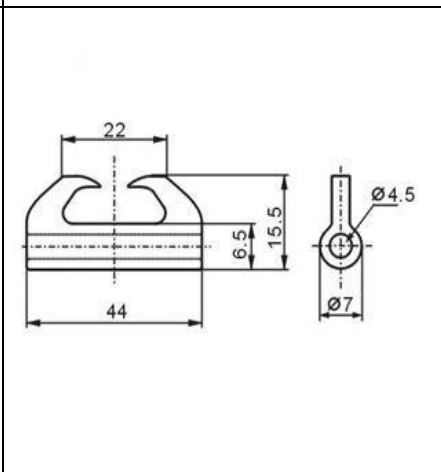

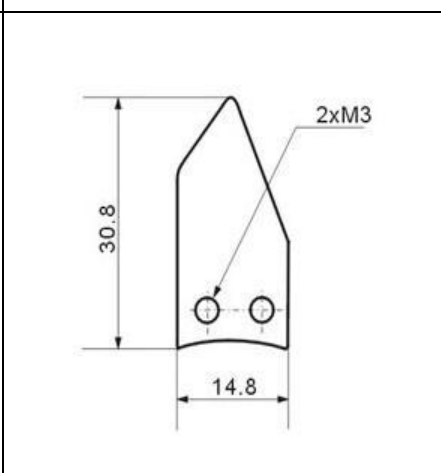

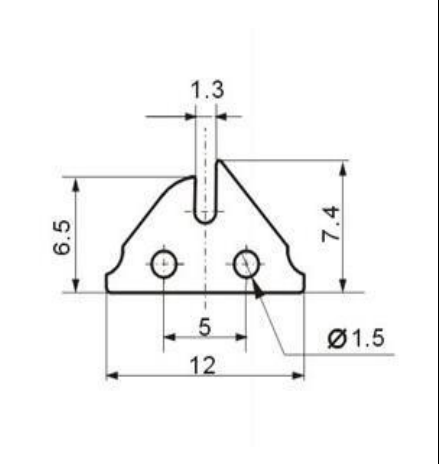

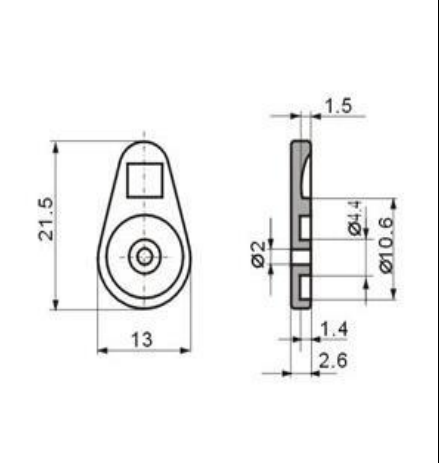

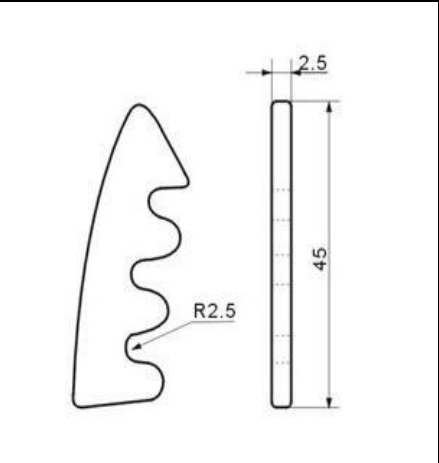

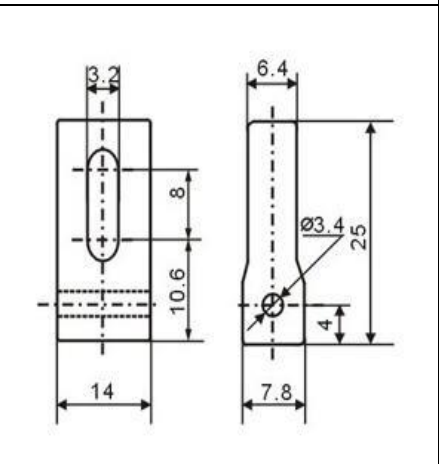
**КЕРАМИЧЕСКИЕ НИТЕВОДИТЕЛИ**

№	ИЗОБРАЖЕНИЕ	СХЕМА	МАТЕРИАЛ
G-1234			99.5% Al <sub>2</sub> O <sub>3</sub>
G-1266			99.5% Al <sub>2</sub> O <sub>3</sub>
G-1267			99.5% Al <sub>2</sub> O <sub>3</sub>
G-1328			99.5% Al <sub>2</sub> O <sub>3</sub>

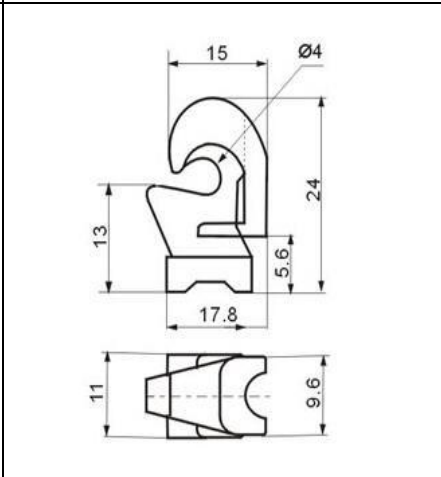

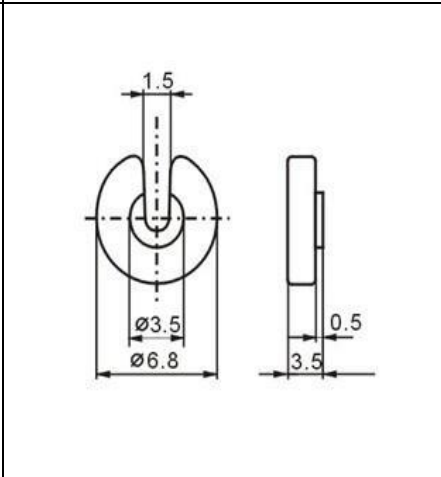

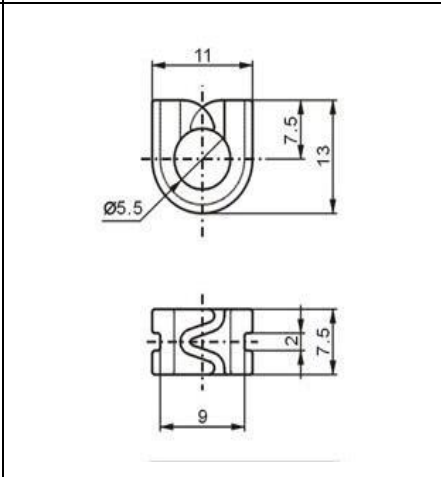
**КЕРАМИЧЕСКИЕ НИТЕВОДИТЕЛИ**

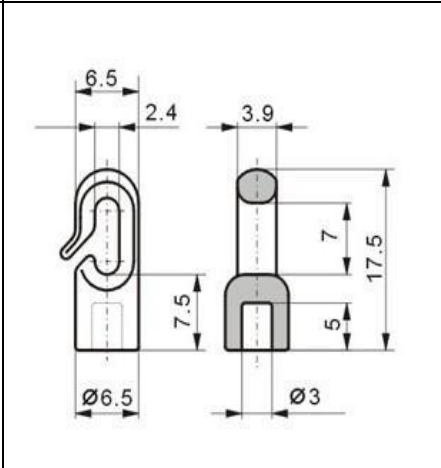
№	ИЗОБРАЖЕНИЕ	СХЕМА	МАТЕРИАЛ
G-1449			99.5% Al <sub>2</sub> O <sub>3</sub>
G-1470			99.5% Al <sub>2</sub> O <sub>3</sub>
G-1508			99.5% Al <sub>2</sub> O <sub>3</sub>
G-1578			99.5% Al <sub>2</sub> O <sub>3</sub>



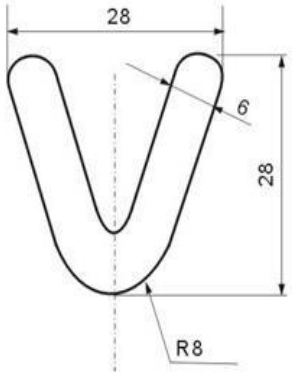
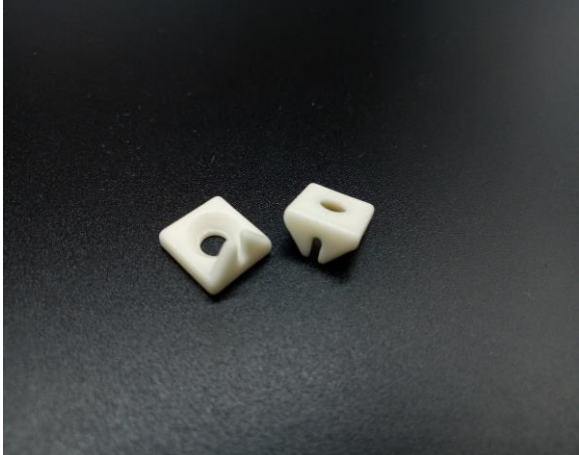
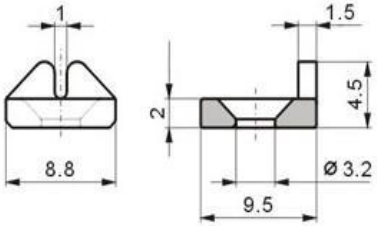

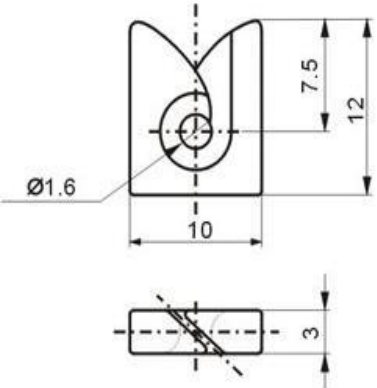
**КЕРАМИЧЕСКИЕ НИТЕВОДИТЕЛИ**

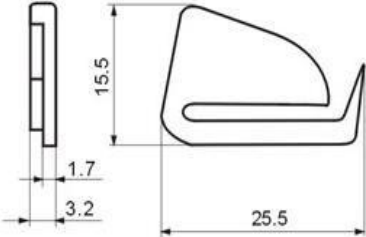
№	ИЗОБРАЖЕНИЕ	СХЕМА	МАТЕРИАЛ
G-1620			99.5% Al <sub>2</sub> O <sub>3</sub>
G-1674			99.5% Al <sub>2</sub> O <sub>3</sub>
G-1713			99.5% Al <sub>2</sub> O <sub>3</sub>
G-1874			99.5% Al <sub>2</sub> O <sub>3</sub>

**КЕРАМИЧЕСКИЕ НИТЕВОДИТЕЛИ**

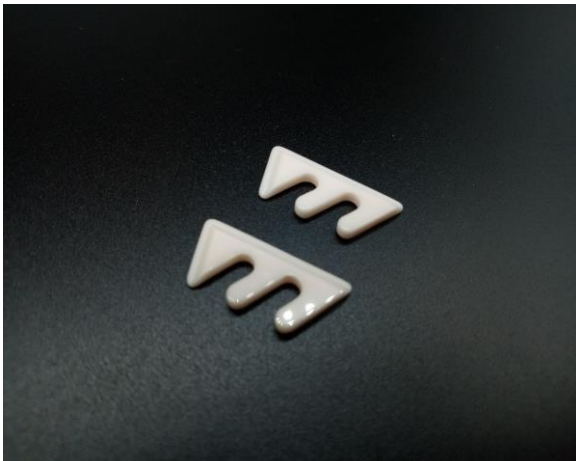
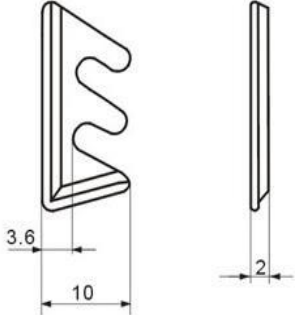
№	ИЗОБРАЖЕНИЕ	СХЕМА	МАТЕРИАЛ
G-1881			99.5% Al <sub>2</sub> O <sub>3</sub>
G-1895			99.5% Al <sub>2</sub> O <sub>3</sub>
G-1907			99.5% Al <sub>2</sub> O <sub>3</sub>
G-1933			99.5% Al <sub>2</sub> O <sub>3</sub>

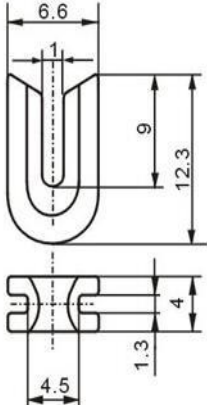
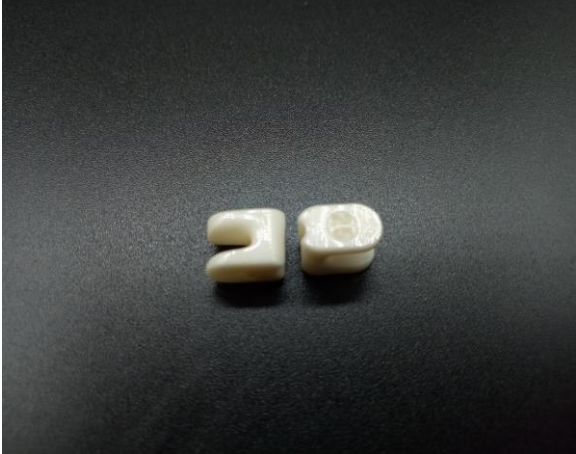
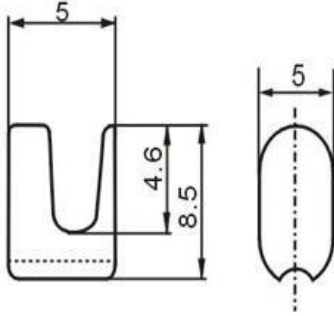
**КЕРАМИЧЕСКИЕ НИТЕВОДИТЕЛИ**

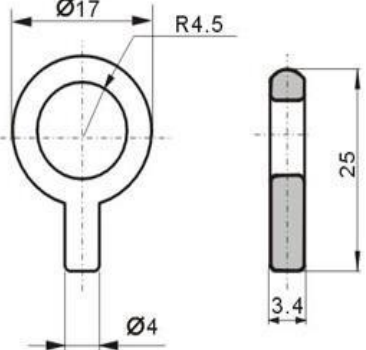
№	ИЗОБРАЖЕНИЕ	СХЕМА	МАТЕРИАЛ
G-1943			99.5% Al <sub>2</sub> O <sub>3</sub>
G-1981			99.5% Al <sub>2</sub> O <sub>3</sub>
G-2000			99.5% Al <sub>2</sub> O <sub>3</sub>
G-2039			99.5% Al <sub>2</sub> O <sub>3</sub>

## КЕРАМИЧЕСКИЕ НИТЕВОДИТЕЛИ

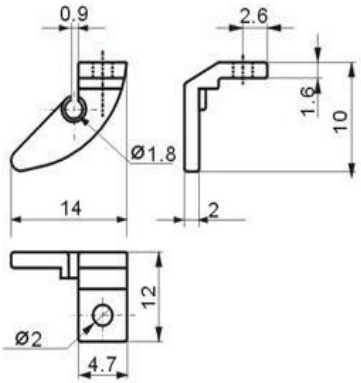
№	ИЗОБРАЖЕНИЕ	СХЕМА	МАТЕРИАЛ
G-2072			99.5% Al <sub>2</sub> O <sub>3</sub>